

1T7951CA | OZ Lighting module - Single

Adjustable magnetic LED light module, powered at low voltage

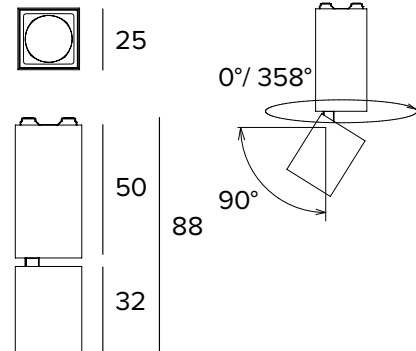

The fixture's photometric values can be found on the following pages



The figures on the drawing are expressed in mm.

SOURCE

Hugh efficiency Ra90 LED Emitter.

Energy efficiency class: G

Nominal power: 2,1W

Nominal flux: 224lm

Colour rendering index: 90

Rf: 87.6

Rg: 103.9

CCT nominal: 2700K

SDCM: 2

Lifetime (L80/B10): >50000h tq +25°C

ILLUMINOTECHNICAL CHARACTERISTICS

Optical unit composed of a specular anodised aluminium reflector, a Lens Vector lens (liquid crystal glass lenses that are electronically controlled to regulate light diffusion and the beam opening) and a holographic filter; UGR<22 (EN12464-1).

Optic: DBS

Beam angles: SP-FL

Optical efficiency: See photometries

Fixture flux: See photometries

Luminous efficacy: See photometries

Photobiological safety: Compliant with RG1 low risk group

MECHANICAL CHARACTERISTICS

Black painted die-cast aluminium body. Adjustable fixture, 25x25mm. Tiltability of the optical unit from 0° to +90° on the vertical plane and of 358° on the horizontal plane.

Colour and finish: Deep black

Dimensions: 25x25mm

Weight: 0.062Kg

Version: ADJUSTABLE CASAMBI

Degree of protection: IP20

ELECTRICAL CHARACTERISTICS

Fixture Power: 3W

Power supply: 48Vdc

Insulation Class: CLASS 3

Class F: YES

Ambient temperature: 0°C / +25°C

INSTALLATION

Extremely rapid, versatile and simple mechanical and electrical coupling system using magnets which support the fixture on the Power Track and feed power inside the fixture on all versions.

NOTES

Version with DBS (Dynamic Beam Shaper) technology. 110-277Vac version available on request. Commissioning of the control system via free APP; the intervention of a specialist technician can be quoted on request.

WARRANTY

5 years.

WARNING

Luminaire designed for disposal/recycling at end-of-life. Replaceable (LED only) light source by a professional. Replaceable control gear by a professional.

Due to the technological evolution of the electronic components, the data provided may be updated, and as such, confirmation must be requested during the order process.

Luminous flux and power supply have +/-10% tolerances with respect to the indicated value. tq +25°C (CIE 121).

We reserve the right to make technical changes.

Targetti Sankey S.r.l.
Via Pratese, 164
50145 Firenze - Italy
Tel: +39 055 37911
targetti.com
targetti@targetti.com

CCIAA Firenze
Share Capital:
€ 500.000,00
VAT N. (IT):
01537660480
R.E.A: FI-275656

TARGETTI

1T7951CA | OZ Lighting module - Single

Adjustable magnetic LED light module, powered at low voltage



	2700K	H(m)	D(m)	Emax(lx)		
	Ra90		16°			
Fixture Power	3W	1	0.28	1598		
Source Flux	224lm	2	0.56	400		
Fixture Flux	166lm	3	0.84	178		
Efficacy	59lm/W	4	1.12	100		
TS1285	I _{max} =7134cd/klm	I _{max}	1598cd	5	1.40	64



	2700K	H(m)	D(m)	Emax(lx)		
	Ra90		35°			
Fixture Power	3W	1	0.62	268		
Source Flux	224lm	2	1.24	67		
Fixture Flux	148lm	3	1.86	30		
Efficacy	53lm/W	4	2.49	17		
TS1286	I _{max} =1198cd/klm	I _{max}	268cd	5	3.11	11

SP

Fixture flux	166lm
Luminous efficacy	59lm/W
Optical efficiency	74%

MWFL

Fixture flux	148lm
Luminous efficacy	53lm/W
Optical efficiency	66%

Due to the technological evolution of the electronic components, the data provided may be updated, and as such, confirmation must be requested during the order process.

Luminous flux and power supply have +/-10% tolerances with respect to the indicated value. tq +25°C (CIE 121).

We reserve the right to make technical changes.

Targetti Sankey S.r.l.
Via Pratese, 164
50145 Firenze - Italy
Tel: +39 055 37911
targetti.com
targetti@targetti.com

CCIAA Firenze
Share Capital:
€ 500.000,00
VAT N. (IT):
01537660480
R.E.A.: FI-275656

TARGETTI